



Top Line Low-Profile Hatches



Hatch



Hatch with Box



Hatch with Box and Dividers



DECK HARDWARE

7x11 | 9x14 Hatch

Hatch Features

- Molded of durable, corrosion-proof high-impact ABS plastic or polyethylene
- Polyethylene hatches are more resistant to chemicals and solvents than ABS hatches
- Structurally reinforced for added strength
- Nonskid diamond pattern
- Rubber gasket creates a watertight seal
- Noncorroding plastic hinges open 180°
- Includes screw hole covers
- Models with locks include two keys

7x11 (8250)

A	B	C	D
7.2" (183mm)	11.4" (289mm)	10.6" (270mm)	14.8" (375mm)
E	F	I	
8.3" (210mm)	12.0" (305mm)	6.3" (160mm)	

Model	Color	Material	Locking	Box	Dividers
44846	white	ABS	-	-	-
47443	ivory	ABS	-	-	-
44848	gray	ABS	-	-	-
195336	white	Poly	-	-	-
195299	ivory	Poly	-	-	-
44849	white	ABS	✓	-	-
47627	ivory	ABS	✓	-	-
44850	gray	ABS	✓	-	-
195336.1	white	Poly	✓	-	-
195299.1	ivory	Poly	✓	-	-
44851	white	ABS	-	✓	-
47628	ivory	ABS	-	✓	-
44852	gray	ABS	-	✓	-
44853	white	ABS	✓	✓	-
47629	ivory	ABS	✓	✓	-
44854	gray	ABS	✓	✓	-
44855	white	ABS	-	✓	✓
47630	ivory	ABS	-	✓	✓
44856	gray	ABS	-	✓	✓
44857	white	ABS	✓	✓	✓
47631	ivory	ABS	✓	✓	✓
44858	gray	ABS	✓	✓	✓

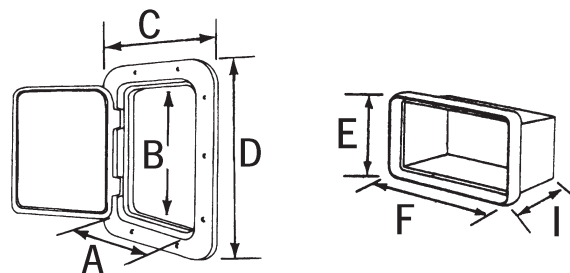

9x14 (8240)

A	B	C	D
9.3" (237mm)	14.1" (357mm)	12.4" (315mm)	17.3" (440mm)

Model	Color	Material	Locking
195236	white	ABS	-
195237	ivory	ABS	-
195238	gray	ABS	-
195287	white	Poly	-
195292	ivory	Poly	-
195239	white	ABS	✓
195240	ivory	ABS	✓
195241	gray	ABS	✓
195287.1	white	Poly	✓
195292.1	ivory	Poly	✓



Top Line Hatches



Lock



Hatch



Hatch with Box

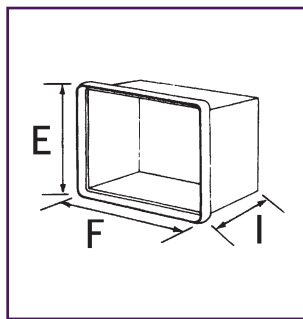
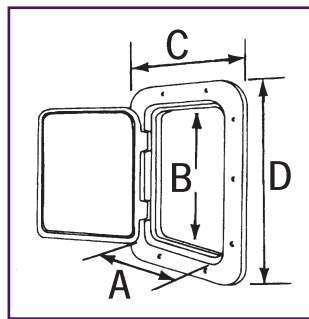

11x11 (8260)

A	B	C	D
11.1" (283mm)	11.4" (289mm)	14.6" (370mm)	14.8" (375mm)
E	F	I	
12.2" (310mm)	12.6" (320mm)	9.6" (245mm)	

Model	Color	Material	Locking	Box
42472	white	ABS	-	-
48690	ivory	ABS	-	-
44863	gray	ABS	-	-
195339	white	Poly	-	-
195342	ivory	Poly	-	-
44864	white	ABS	✓	-
47632	ivory	ABS	✓	-
44865	gray	ABS	✓	-
195339.1	white	Poly	✓	-
195342.1	ivory	Poly	✓	-
44866	white	ABS	-	✓
47633	ivory	ABS	-	✓
44867	gray	ABS	-	✓
44868	white	ABS	✓	✓
47634	ivory	ABS	✓	✓
44869	gray	ABS	✓	✓

15x17 (8270)

A	B	C	D
14.7" (373mm)	17.0" (433mm)	18.1" (460mm)	20.0" (510mm)
E	F	I	
15.6" (395mm)	17.5" (445mm)	13.0" (330mm)	

Model	Color	Material	Locking	Box
44875	white	ABS	-	-
47635	ivory	ABS	-	-
44876	gray	ABS	-	-
195345	white	Poly	-	-
195348	ivory	Poly	-	-
44877	white	ABS	✓	-
47636	ivory	ABS	✓	-
44878	gray	ABS	✓	-
195345.1	white	Poly	✓	-
195348.1	ivory	Poly	✓	-
44879	white	ABS	-	✓
47637	ivory	ABS	-	✓
44880	gray	ABS	-	✓
44881	white	ABS	✓	✓
47638	ivory	ABS	✓	✓
44882	gray	ABS	✓	✓

DECK HARDWARE

11x11 | 15x17 Hatch



Top Line Hatches



Hatch



Hatch with Box



Lock

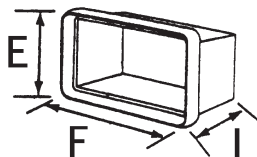
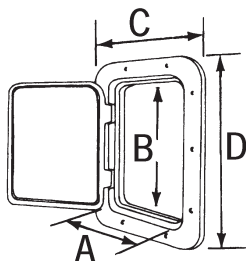

11x21 (8280)

A	B	C	D
10.5" (266mm)	20.5" (520mm)	13.9" (353mm)	23.9" (606mm)

E	F	I
11.4" (290mm)	21.3" (540mm)	11.5" (293mm)

Model	Color	Material	Locking	Box
42473	white	ABS	-	-
47639	ivory	ABS	-	-
44891	gray	ABS	-	-
195351	white	Poly	-	-
195302	ivory	Poly	-	-
44892	white	ABS	✓	-
47640	ivory	ABS	✓	-
44893	gray	ABS	✓	-
195351.1	white	Poly	✓	-
195302.1	ivory	Poly	✓	-
44894	white	ABS	-	✓
47641	ivory	ABS	-	✓
44895	gray	ABS	-	✓
44896	white	ABS	✓	✓
47642	ivory	ABS	✓	✓
44897	gray	ABS	✓	✓

7x21 (8290)

A	B	C	D
6.4" (162mm)	20.5" (521mm)	9.6" (243mm)	24.0" (607mm)

Model	Color	Material	Locking
47067	white	ABS	-
47643	ivory	ABS	-
47068	gray	ABS	-
195354	white	Poly	-
195357	ivory	Poly	-
47069	white	ABS	✓
47644	ivory	ABS	✓
47070	gray	ABS	✓
195354.1	white	Poly	✓
195357.1	ivory	Poly	✓

DECK HARDWARE

11x21 | 7x21 Hatch

Top Line Hatch Accessories



44206 ABS Handle
195291 Poly Handle



44554 Topline Gasket



44813 Lock



Top Line Screw-in Inspection Plates

- Matches Top Line Hatches
- ABS plastic
- O-rings provide a watertight fit
- White

Model	Color	Material	Interior Dimensions (B)	Exterior Dimensions (C)
47073	white	ABS	4.3" (108mm)	6.4" (162mm)
47734	ivory	ABS	4.3" (108mm)	6.4" (162mm)
47075	white	ABS	5.3" (133mm)	7.4" (187mm)
47735	ivory	ABS	5.3" (133mm)	7.4" (187mm)
47077	white	ABS	7.2" (188mm)	8.8" (222mm)
47736	ivory	ABS	7.2" (188mm)	8.8" (222mm)

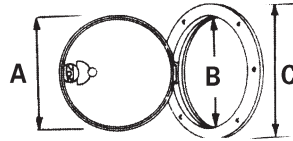

Value Line Screw-in Inspection Plates

- ABS plastic
- O-rings provide a watertight fit.

Model	Color	Material	Interior Dimensions (B)	Exterior Dimensions (C)
43909	white	ABS	4.0" (104mm)	5.4" (143mm)
47731	ivory	ABS	4.0" (104mm)	5.4" (143mm)
43918	white	ABS	5.3" (130mm)	6.8" (170mm)
47732	ivory	ABS	5.3" (130mm)	6.8" (170mm)
43927	white	ABS	6.1" (155mm)	7.8" (200mm)
47733	ivory	ABS	6.1" (155mm)	7.8" (200mm)

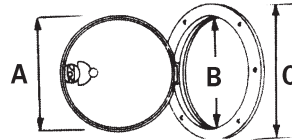

Inspection Plates with Twist-to-Open Handle

Locking



Non-Locking

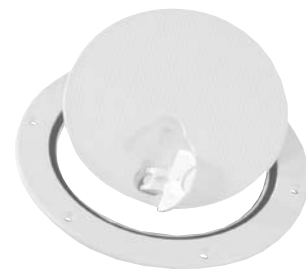

Model	Color	Material	Locking	Plate Dimensions (A)	Interior Dimensions (B)	Exterior Dimensions (C)
42791	white	ABS	-			
47726	ivory	ABS	-			
43585	white	ABS	✓	9.0" (203mm)	7.5" (190mm)	10.4" (265mm)
47728	ivory	ABS	✓			
43565	white	ABS	-			
47725	ivory	ABS	-			
43579	white	ABS	✓	9.9" (250mm)	9.3" (235mm)	12.4" (315mm)
47727	ivory	ABS	✓			

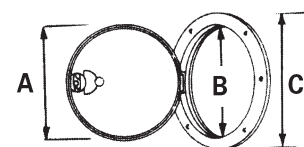

DECK HARDWARE

Screw-in Inspection Plates

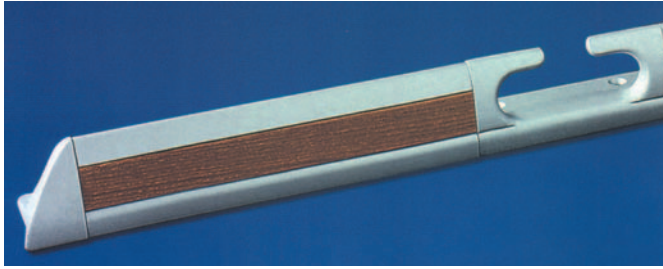

• Can be highlighted with teak batten accent trim

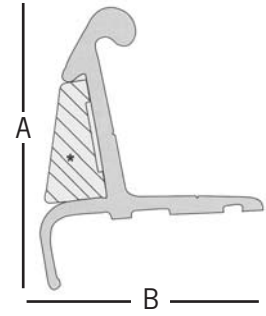

Image	Model	Description	Length	Diagram Height "A"	Diagram Width "B"	Hole Spacing
	97818	Toe Rail	19.7' (6m)	2.4" (60mm)	1.9" (47mm)	7.9" (200mm)
	97793*	Set, short ends, solid	6.9" (175mm)	2.4" (60mm)	1.9" (47mm)	-
	97797*	Set, fairlead ends, closed	6.9" (175mm)	2.4" (60mm)	1.9" (47mm)	1.4" (35mm)
	97795*	Set, fairlead ends, open	6.9" (175 mm)	2.4" (60mm)	1.9" (47mm)	3.3" (85mm)
	105601*	Middle fairlead	5.3" (135mm)	2.4" (60mm)	1.9" (47mm)	3.3" (85mm)
	97800*	Set, fairlead ends, open (boats >35')	9.1" (230mm)	2.8" (70mm)	2.1" (50mm)	6.1" (155mm)
	97799*	Middle fairlead (boats >35')	7.1" (180mm)	2.8" (70mm)	2.1" (50mm)	6.1" (155mm)
	105538*	Teak accent trim	6.6' (2m)	-	-	-
	97798	Assembly rail connector	4.7" (120mm)	1.3" (33mm)	3.5" (90mm)	-
	97796*	Aluminum stanchion base	1.8" (46mm)	2.8" (70mm)	2.4" (61mm)	-

*shown with optional teak piece

811 Toe Rail

- Designed for boats 35-40' (10-12m)
- Slightly angled profile and a flat surface
- Rectangular cutouts: 2.6" x 1.14" (65x29mm)
- Spacing: 9.0" (225mm)

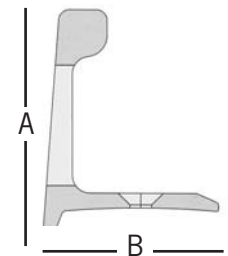
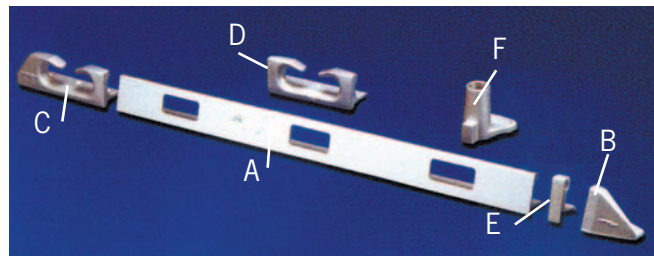
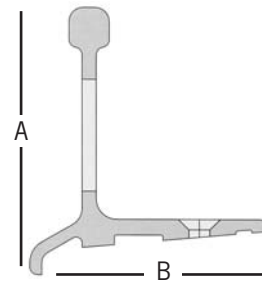
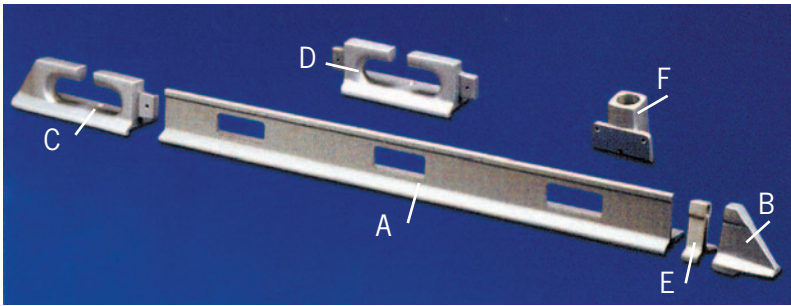

Image	Model	Description	Length	Diagram Height "A"	Diagram Width "B"	Hole Spacing
	97824	Toe Rail	19.7' (6m)	2.2" (55mm)	1.7" (44mm)	4.4" (112mm)
	97801	Set, short ends, solid	2.8" (70mm)	2.3" (58mm)	2.0" (50mm)	-
	97804	Set, fairlead ends, closed	7.1" (180mm)	2.1" (52mm)	1.8" (45mm)	2.4" (61mm)
	97767	Middle fairlead	5.9" (150mm)	2.2" (55mm)	1.8" (45mm)	2.3" (59mm)
	105643	Assembly rail connector	0.6" (15mm)	2.3" (58mm)	1.9" (47mm)	-
	97436	Aluminum stanchion base	3.2" (80mm)	3.0" (77mm)	3.5" (85mm)	2.2" (57mm)



822 Toe Rail



- Designed for boats 45' (13.7m) and larger
- Straight vertical shape
- Rectangular cutouts: 2.8" x 1.08" (70x27mm)
- Spacing: 9.0" (225mm)

Image	Model	Description	Length	Diagram Height "A"	Diagram Width "B"	Hole Spacing
A	97831	Toe Rail	19.7' (6m)	2.6" (67mm)	2.3" (59mm)	4.4" (112mm)
B	97805	Set, short ends, solid	2.6" (65mm)	2.8" (70mm)	2.7" (68mm)	-
C	97807	Set, fairlead ends, closed	7.9" (200mm)	2.8" (70mm)	2.4" (61mm)	3.0" (75mm)
D	105598	Middle fairlead	6.5" (165mm)	2.8" (70mm)	2.4" (61mm)	-
E	97783	Assembly rail connector	0.8" (20mm)	2.8" (72mm)	2.7" (68mm)	-
F	97437	Aluminum stanchion base	3.0" (77mm)	2.8" (70mm)	1.6" (40mm)	2.4" (60mm)

823 Toe Rail

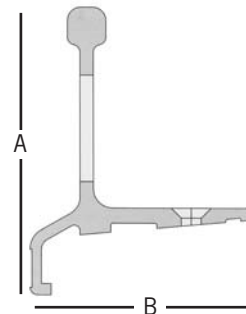
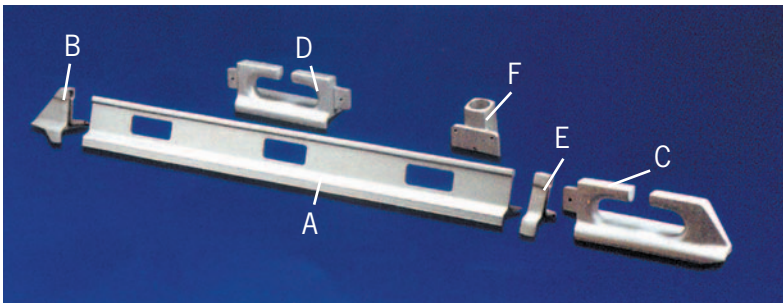

- Designed for boats 45' (13.7m) and larger
- Taller flange than 822 toerail
- Rectangular cutouts: 2.8" x 1.08" (70x27mm)
- Spacing: 9.0" (225mm)

Image	Model	Description	Length	Diagram Height "A"	Diagram Width "B"	Hole Spacing
A	97841	Toe Rail	19.7' (6m)	3.0" (76mm)	2.3" (59mm)	4.4" (112mm)
B	97809	Set, short ends, solid	2.6" (65mm)	3.2" (80mm)	2.6" (67mm)	-
C	97811	Set, fairlead ends, closed	7.9" (200mm)	3.1" (78mm)	2.4" (61mm)	3.0" (75mm)
D	97810	Middle fairlead	6.5" (165mm)	3.1" (78mm)	2.4" (61mm)	-
E	97737	Assembly rail connector	0.8" (20mm)	3.1" (79mm)	2.6" (67mm)	-
F	97437	Aluminum stanchion base	3.0" (77mm)	2.8" (72mm)	1.6" (40mm)	2.4" (60mm)



Stanchion Bases



Model	Construction	Shape	Inclination
97430	Aluminum	Triangle	0°
97442	Stainless	Triangle	0°
97440	Stainless	Triangle	5°
97439	Stainless	Square	0°
97441	Stainless	Square	5°

1" Stainless Steel Stanchions



Tapered tip model	Spherical tip model	Description*	Overall Height	Lifeline-to-tip Distance
97443	93633	1 lifeline hole	17.75" (45cm)	-
97445	93634	1 lifeline hole 0 mounting holes	17.75" (45cm)	-
97444	93635	2 lifeline holes	17.75" (45cm)	8.875" (22.5cm)
105505	105897	2 lifeline holes	24.1" (61cm)	12.1" (30.5cm)
105470	93637	2 lifeline holes†	24.75" (63cm)	12" (30cm)
105786	93638	2 lifeline holes 0 mounting holes	24.75" (63cm)	12" (30cm)
105787	105898	2 lifeline holes	26.75" (68cm)	12" (30cm)
97449	-	2 lifeline holes	29.5" (75cm)	14.4" (36cm)

* Except where noted, all stanchions have a single mounting hole drilled perpendicular to the lifeline hole(s), through a single wall of the stanchion, at 1.4" (35mm) above the base.

† Models 105470 and 93637 have an additional mounting hole drilled parallel to the lifeline holes, through both walls of the stanchion, at 1.8" (45mm) above the base.

Stanchion Gates



97451 Gate Stanchion

105789 Gate Door

- Can be used with any Goïot stanchion
- Designed to accommodate two lifelines
- Gates are 24.6" (61.5cm) high
- Distance between lifeline holes is 11.4" (28.5cm)
- Distance between leg fastening holes at base is 11.2" (28cm)

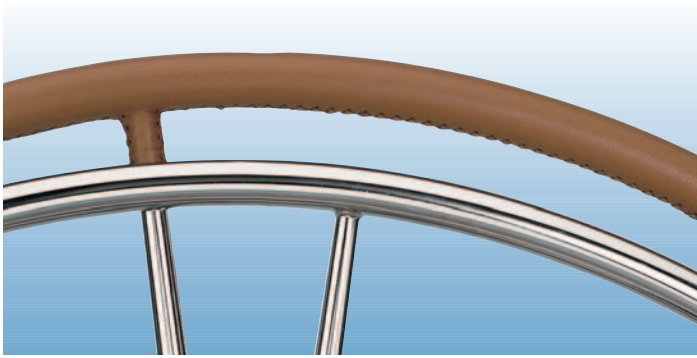

Wheels

- Five tapered spokes
- Stainless steel
- Leather covered wheels supplied with hub are compatible with Goiot, Lewmar, Whitlock, and Edson 1" tapered steerers

Diameter	Stainless Steel with Leather Cover 25mm Hub*	Stainless Steel with Leather Cover 35mm Hub**	Stainless Steel***	Carbon Fiber
31.5" (800mm)	-	115036	97037	-
35.5" (900mm)	115403	115037	97042	106814
39.3" (1000mm)	115394	115038	97026	-
43.3" (1100mm)	-	115039	-	-
47.2" (1200mm)	115404	115040	105746	-

*For use with Goiot, Lewmar (with brake), Whitlock (with brake) and Edson (1" tapered) steerers

**For use with Goiot, Lewmar (without brake) and Whitlock (without brake) steerer

***Supplied without hub

Steer'n Go Wheel

- 316 stainless steel construction
- Stainless steel hub with stainless steel ball bearings for friction free operation
- Optional leather sheath, brandy color
- Easy to mount and remove, the Steer'n Go hub is mounted on the existing shaft. Once the hub is in place, operation is achieved by simply pressing the flange
- Compatible with Goiot, Lewmar, Whitlock, and Edson 1" tapered steerers

Steer'n Go Wheel	Without Sheath	With Leather Sheath
32" (815mm)	105241	105245
36" (915mm)	105242	105246
40" (1030mm)	105243	105247
47" (1200mm)	105244	105248

Accessories

105249 Pulpit Bracket

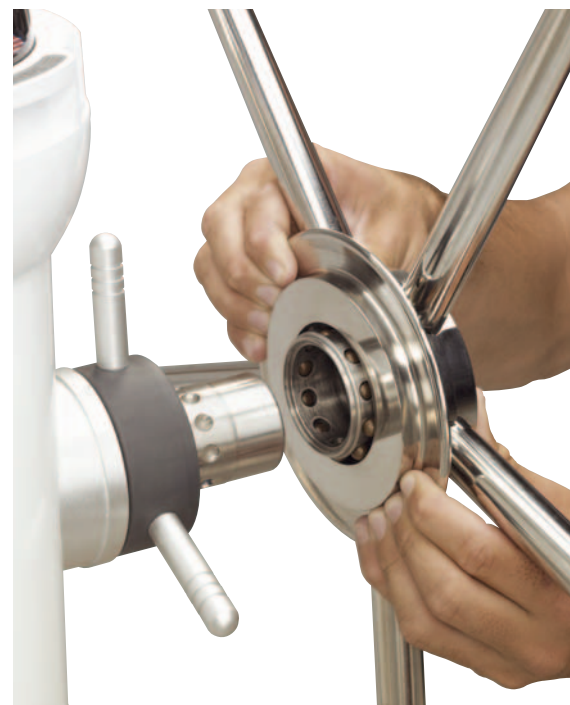



Spreader Boots

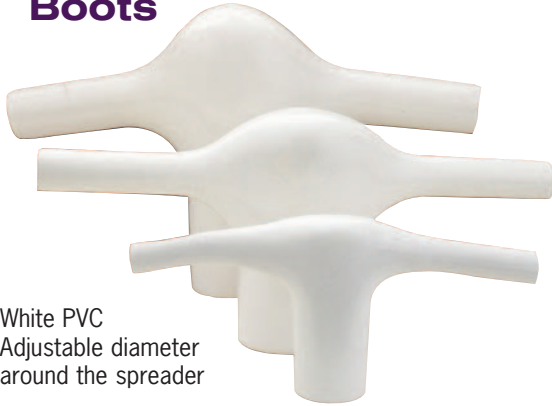

- White PVC
- Adjustable diameter around the spreader

Model	Spreader Shape	Wire Diameter
17060	Flat	3/16"-1/4" (4-6mm)
17061	Flat	5/16"- 1/2" (7-12mm)
17062	Round	1/4" (6mm)
17063	Round	3/8" (9mm)
17064	Round	1/2" 912mm)
10633	Round	3/4" (19mm)

Underwater Viewers



- 31409** Round, 13" dia. x 20"H
stores at 13" dia. x 9"H
- 43350** Rectangular, 6.6"W x 7.8" base x 16"H
- Round bathyscope disassembles into three nesting pieces for compact storage

Nylon Cleats

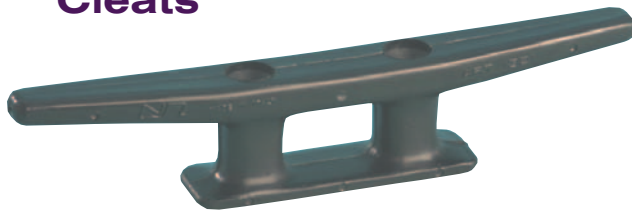

- Noncorroding black nylon cleats for light duties
- Fasteners not included

Model	Overall Length	Hole-to-Hole Distance
43378	2.4" (60mm)	.76" (19mm)
43381	3.2" (80mm)	.88" (22mm)
43384	4.4" (110mm)	1.12" (28mm)
43387	5.8" (145mm)	1.4" (35mm)
43390	7.2" (180mm)	1.8" (45mm)
43393	8.8" (220mm)	2.08" (52mm)