

Opal Hatches

- One-piece aluminum lid with a thick frame section to provide optimum rigidity
- Slim, 3/4" (19mm) lid height
- Must be mounted on a flat surface
- CE approved areas: II, III, and IV
- Adjustable stay to 160°, or release the stay for 180°
- Available in .59" (15mm) or .95" (24mm) thickness of flange
- Available in satin, white or high-polish finish
- Cut Radius 1.67" (42.5 mm) except sizes 18, 51, 65
- Blue acrylic is supplied as standard; Green acrylic by special order
- Acrylic thickness: .39" (10mm)

GoïOT

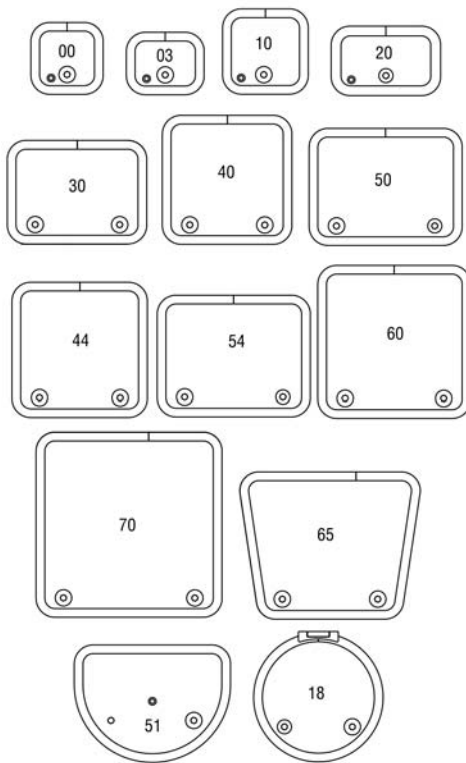

Size	Satin finish* Flange size		Trim Ring	Shade/** Screen	Overall Dimensions	Cut-out Dimensions
	15mm (.59")	24mm (.95")				
00	115263	-	115353	-	10.4" x 10.4" 265 x 265mm	8.3" x 8.3" 211 x 211mm
03	115264	-	115354	-	11.2" x 9.1" 285 x 230mm	9.1" x 6.9" 231 x 176mm
10	106732	105252	115306	115175	12.4" x 12.4" 314 x 314mm	10.2" x 10.2" 260 x 260mm
18	115406	115407	115440	115448	18.7" 474mm	Ø 16.5" 420mm
20	106733	105253	115355	115176	15.8" x 10.1" 401 x 256mm	13.7" x 8" 347 x 202mm
30	106734	105254	115356	115177	20.1" x 15" 511 x 381mm	18" x 12.9" 457 x 327mm
40	106735	105255	115357	115178	18.7" x 18.7" 475 x 475mm	16.6" x 16.6" 421 x 421mm
44	106736	105256	106086	115179	19.5" x 19.5" 496 x 496mm	17.4" x 17.4" 442 x 442mm
50	115267	-	115439	115447	20.0" x 14.8" 507 x 377mm	22.1" x 17.0" 561 x 431mm
51	115453	115454	-	-	22.5" x 17.0" 572 x 432mm	20.4" x 14.9" 518 x 378mm
54	106737	105257	115358	115181	22.1" x 17.6" 561 x 446mm	20" x 15.4" 507 x 392mm
60	106738	105258	115359	115182	22.1" x 22.1" 561 x 561mm	20" x 20" 507 x 507mm
65	106754	-	115444	115452	22.1" x 22.1-26.6" 560 x (560-675)mm	19.9" x (19.9-24.4)" 506 x (506-621)mm
70	106739	105259	115392	115183	26.8" x 26.8" 681 x 681mm	24.7" x 24.7" 627 x 627mm

*Also available in white and high-polish aluminum (see price list)

**FLY screen only available for 24mm models by special order



Optional shade/screen system



Locking handles



Double contact seal system

Quick Closing Ventilator

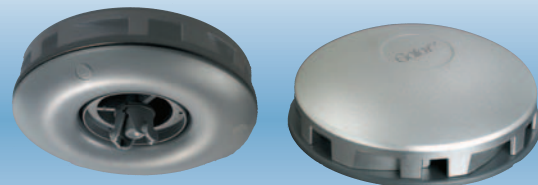

105033

- Aluminum body with ABS open/shut system
- Spring pop-out knob for easy operation
- Rubber seal provides watertightness – no caulk needed
- Hatches can be special ordered with vent cut-out

VENTILATION

Opal Hatches | Hatch Vent

Tradition Aluminum Hatches

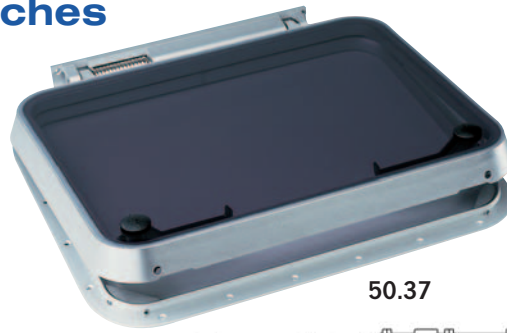

- Top and bottom frames are single piece cast
- Lids are anodized and hand polished
- Friction hinges keep the hatch open at any angle up to 180°
- Handles feature two-position locks - closed or ventilation
- Acrylic lenses resist scratches, crazing, UV-degradation, and are 1/5" - 3/5" (5-15mm) thick
- Leakproof in all conditions
- Cutout radius; 1.6" (41mm)

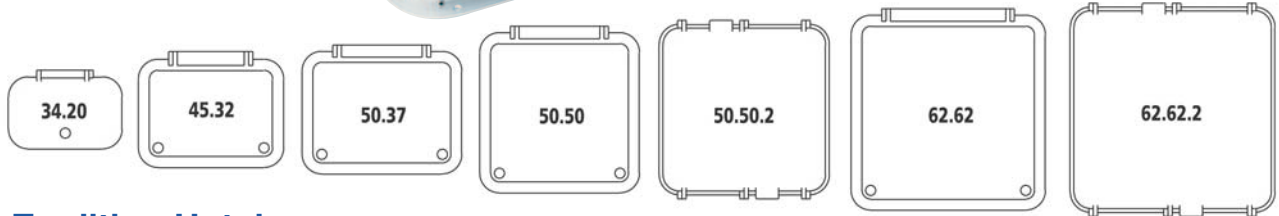

Tradition Hatches

Size	Model	Model w/out handles	Overall Dimension	Cutout Dimension	Height above deck	Spare lens ****	Gasket ***	Screen	Bubble **
34.20	102369	-	15.6" x 10.6" 395 x 270mm	13.6" x 7.8" 340 x 195mm	1.6" 40mm	101200	95661	-	-
45.32	102370	102383	19.8" x 15.8" 504 x 402mm	17.7" x 12.6" 450 x 320mm	1.7" 44mm	101174	95661	93462	-
50.37	102371	102396	21.8" x 17.6" 554 x 451mm	19.7" x 14.6" 500 x 370mm	1.8" 46mm	101175	95661	93464	-
50.50	102372	102410	23.3" x 21.8" 591 x 554mm	19.7" x 19.7" 500 x 500mm	1.8" 46mm	101176	95661	93468	95317
62.62	102373	102429	27.6" x 26.5" 701 x 674mm	24.4" x 24.4" 620 x 620mm	1.9" 48mm	101177	95661	93473	95318
80.80*	102445*	-	37.8" x 35.4" 960 x 900mm	31.5" x 31.5" 800 x 800mm	2.4" 60mm	101145	95665	-	-

*Made to order, allow extra delivery time
**Special order only

*** 105697 glue for gasket
****101715 glue set for spare lens



Sliding Hatch

See replacement parts & accessories on page 78



Escape Hatch

Escape Hatches come with outside handles and inside locking bar that must be removed when underway.

Specialty Tradition Hatches

Size	Model	Description	Overall Dimension	Cutout Dimension*	Cutout Radius	Height above deck	Gasket ***
62.62.6	102440*	Sliding Hatch	51.5" x 27.9" 1309 x 709mm	24.4" x 24.4" 620 x 620mm	1.6" 41mm	3.1" 79mm	95661
72.72.6	102442*	Sliding Hatch	59.4" x 31.9" 1509 x 809mm	28.3" x 28.3" 720 x 720mm	1.6" 41mm	3.1" 79mm	95661
50.50.2	102420*	Two-way Hatch	24.3" x 23.2" 616 x 590mm	19.7" x 19.7" 500 x 500mm	1.0" 25mm	2.1" 52mm	95665
62.62.2	102438*	Two-way Hatch	29.0" x 28.0" 736 x 710mm	24.4" x 24.4" 620 x 620mm	1.0" 25mm	2.1" 54mm	95665
45.32	102387*	Escape Hatch**	19.8" x 15.8" 504 x 402mm	17.7" x 12.6" 450 x 320mm	1.6" 41mm	1.7" 44mm	-
50.37	102398*	Escape Hatch**	21.8" x 17.6" 554 x 451mm	19.7" x 14.6" 500 x 370mm	1.6" 41mm	1.8" 46mm	-
50.50	102417*	Escape Hatch	23.3" x 21.8" 591 x 554mm	19.7" x 19.7" 500 x 500mm	1.6" 41mm	1.8" 46mm	-

*Clearing dimensions are the same as cut-out dimensions
**For boats <40' (12m)

Tradition Portlights

- Constructed in cast aluminum
- Leakproof in all conditions
- Lenses are 1/4" (6mm) thick
- Friction hinges keep the lens open in any position from 0° to 180°
- Available in several thicknesses



34.14

GOÏOT

See replacement parts & accessories on page 79



Size	Depth .32-.8" (8-20mm)	Depth .96" (20mm)	Depth .4" (10mm)	Depth .6" (15mm)	Depth 1.36" (34mm)	Overall Dimensions	Cutout Dimensions	Shutter	Screens	Spare Lens
21.21	-	99648*	-	-	-	Ø10.2" Ø260mm	Ø8.7" Ø220mm	99371	-	99375
24.11	-	99658	-	-	-	12" x 6.9" 305 x 175mm	9.9" x 4.8" 252 x 122mm	-	93992	99379
34.14	99681	99671	-	-	99683	15.9" x 7.9" 404 x 201mm	13.9" x 5.9" 353 x 150mm	99690	93847	99454
34.15	-	-	99693	99694	-	16.0" x 8.1" 406 x 206mm	14.1" x 6.3" 359 x 159mm	99698	-	99240
34.18	99704	99700	-	-	-	15.9" x 9.6" 405 x 245mm	13.8" x 7.5" 350 x 191mm	-	99705	99457

*95667 gasket compatible with all traditional portlights. 105697 glue for gasket.

*101715 glue set for spare lens

Opal Portlights

- Designed to match Opal Hatch range
- One-piece, thick frame for rigidity
- Double contact seal system (see Opal hatch)
- Unique reversible backing plate allows installation over a wide range of cabin wall thickness
- Blue acrylic is supplied as standard
- Acrylic thickness: .39" (10mm)
- Available in satin, white or high-polish finish

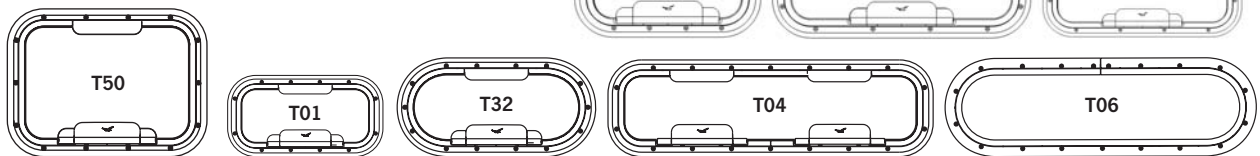
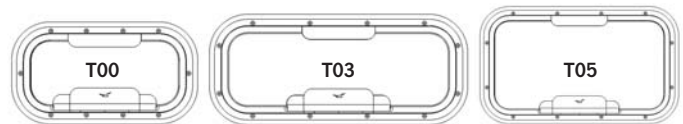

	Satin*		High-polish*		Screen	Wall Thickness	Overall Dimensions	Cut-out Dimensions	Cut-out Radius
	Opening	Fixed	Opening	Fixed					
00	106928	-	106929	-	-	.2" - 1.3" 5 - 33 mm	12.8" x 7.0" 325 x 178mm	11.9" x 6.1" 303 x 156mm	2.2" 56mm
01	105268	-	106239	-	106620	.2" - 1.3" 5 - 33 mm	14.5" x 7.6" 369 x 1192mm	13.7" x 6.7" 347 x 171mm	2.2" 56mm
03	115006	-	115007	-	-	.2" - 1.3" 5 - 33 mm	17.6" x 7.6" 451 x 193mm	16.9" x 6.7" 429 x 171mm	2.2" 56mm
04	105269	-	106240	-	106621	.2" - 1.3" 5 - 33 mm	25.6" x 7.6" 649 x 192mm	24.7" x 6.7" 627 x 171mm	2.2" 56mm
05	106930	-	106931	-	-	.2" - 1.3" 5 - 33 mm	17.8" x 10.5" 451 x 266mm	16.9" x 9.6" 429 x 244mm	2.2" 56mm
06	-	105124	-	106215	-	.3" - 1.3" 8 - 33 mm	24.5" x 7.7" 622 x 196mm	23.6" x 6.9" 600 x 175mm	3.4" 87.5mm
32	105125	-	106217	-	106618	.2" - 1.3" 5 - 33 mm	15.6" x 7.7" 397 x 197mm	14.8" x 6.9" 375 x 175mm	3.4" 87.5mm
32	-	105847	-	106216	-	.3" - 1.3" 8 - 33 mm	15.6" x 7.7" 397 x 197mm	14.8" x 6.9" 375 x 175mm	3.4" 87.5mm
50	105126	-	106218	-	106619	.2" - 1.3" 5 - 33 mm	14.5" x 10.7" 369 x 273mm	13.7" x 9.9" 347 x 251mm	2.2" 56mm









*Also available in white finish

VENTILATION











Tradition Portlights | Opal Portlights





Goiot Tradition Hatches - Spare Parts

Image	Model	Description
	93474	Starboard handle (each) (hatch opening forward) (9494)
	93475	Port handle (each) (hatch opening forward) (9595)
	101691	Pair of inside right/left handles and hardware
	101686	Outside handle (x2)
	105743	Friction ring (x4)
	100870	Piston locking knob for 80.80 size (x2)
	101711	Aluminum latch (rivets included) for 45.32, 50.37, 62.62 and 80.80 size (x2)
	93476	Plastic latch (rivets included) for 34.20 size (x2)
	95345	Hinge axle for 80.80 size, .39"(10mm) diam. (x2)
	100863	Aluminum opening device for 80.80 size (each)
	93477	Pair of interior/exterior aluminum handles (right and left). For Tradition Escape hatch only.

Goiot Cristal Hatches - Spare Parts

Image	Model	Description
	95330	Small inside handle (x2)
	101704	Pair of large interior handles
	93480	Inside cap for large handle (x2)
	101687	Outside handle (x2)
	105743	Friction ring (x4)
	93481	Lock (each)
	101706	Friction set for 24.19, 24.24, 35.21, 36.14, 36.19, 36.24, 49.19, 49.24 sizes (x2)
	101708	Friction set for 42.42, 44.31, 44.44, 44C, 49.36 sizes (x2)
	100870	Piston locking knob for 79.79 size (x2)
	105020	Pair of interior/exterior aluminum handles for Cristal Escape hatch (left and right)

Goiot Integration Hatches - Spare Parts

Image	Model	Description
	101713	Pair of small inside handles
	101704	Pair of large interior handles for 46.33 size
	101692	Opening stay for 46.33 size (each)

Replacement Parts



Goiot Original Hatch with opening stay - Spare Parts

Image	Model	Description
	100870	Opening stay locking knob (x2)
	95344	Tightening knob "seagull knob" (x2)
	99468	Tightening knob screw (x2)
	100869	Tightening knob scew for two-way hatch (x2)
	95345	Nylon hinge axle Ø 10mm for 34.20 size (x2)
	100863	Opening device (aluminum handles) for 118, 118-0, 119 bis hatches
	101694	Set of opening stay for 116 model (500 x 500mm)
	101695	Set of opening stay for 116L model (500 x 500mm two-way hatch)
	101696	Set of opening stay for 117 model (620 x 620mm)

Goiot Tradition Portlights - Spare Parts

Image	Model	Description
	105715	Friction set for 24.11, 34.14, 34.18, 34.15 sizes (x2)
	95344	Tightening knob (black seagull knob) (x2)
	99468	Tightening knob or hinge axle 8mm (x2)
	95343	Axle for tightening knob or hinge axle (8mm) (x2)
	93482	Rubber knob for round ports 44.22 and 54.32 sizes (x10)

Goiot Cristal Portlights - Spare Parts

Image	Model	Description
	101706	Friction set (x2)
	95331	Latch (x2)
	95332	Handle (x2)
	99247	Left hinge (each)
	99246	Right hinge (each)
	99254	Handle bushing (each)

Goiot Evolution Portlights - Spare Parts

Image	Model	Description
	101706	Friction set (x2)
	95335	Latch (x2)
	95336	Handle (x2)
	99488	Hinge kit (x2)

Gasket and Lens Adhesive

Model	Description
105697	Glue for gaskets
101715	Glue set (glue and primer) for acrylic lenses



Top Line Low-Profile ABS Hatches with Acrylic Lenses

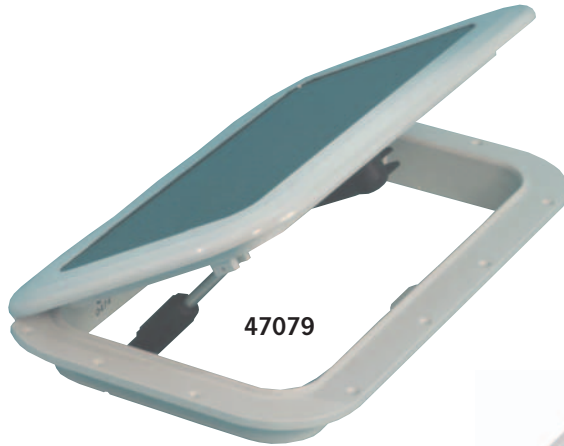

47079

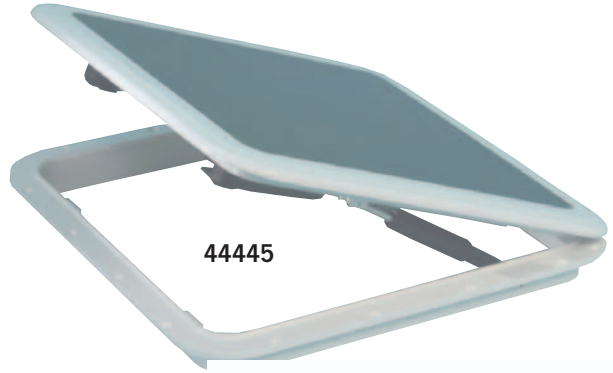

44445



195256



- Low-profile
- Corrosion-proof high-impact ABS plastic
- 3/4" (2cm) smoke acrylic lenses
- Rubber gasket creates a watertight seal
- Noncorroding plastic hinges open the hatch to 90°
- Twist-lock riser arm locks the open hatch in place anywhere from 0° to 90°
- Includes screw hole covers
- White

Model	Shape	External Dimension	Internal Dimension	Cutout	Height above deck	Riser Arm	Gasket	Handle Kit
47079	Rectangular	17.6" x 10.6" 448 x 268mm	14.8" x 7.7" 376 X 196mm	15.3" x 8.2" 389 x 209mm	.8" 20mm	47089	44560	50001
44445	Square	18.9" x 18.9" 480 x 480mm	16.3" x 16.3" 415 x 415mm	16.9" x 16.9" 430 x 430mm	.8" 20mm	44839	44560	44208
195256	Round	Ø14.9" Ø378mm	Ø11.6" Ø294mm	Ø12.2" Ø309mm	1.0" 26mm	195541	195543	195540
195254	Round	Ø23.2" Ø590mm	Ø19.9" Ø506mm	Ø20.5" Ø521mm	1.1" 27mm	195542	195543	195540

Top Line Louvered Vents

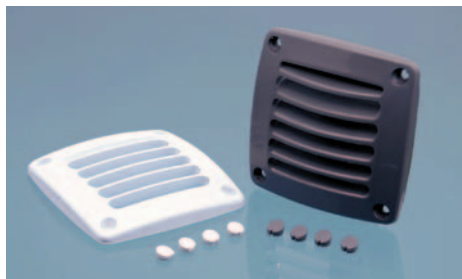

- ABS plastic
- Predrilled fastener holes
- Screw covers included

	White	Ivory	Dimensions
Small Square	47063	47441	3.6" x 3.6" 92 x 92mm
Large Square	50152	50153	4.6" x 4.6" 118 x 118mm
Rectangular	47065	47440	8.1" x 4.2" 206 x 106mm

Streamlined Dorade Box

51637

- Shock and UV resistant polyamide
- Sits 3.4" above the deck
- Can be closed from the inside to prevent accidental water intrusion
- Supplied with: Dorade body, shut-off system, (85mm) sleeve, white trim ring

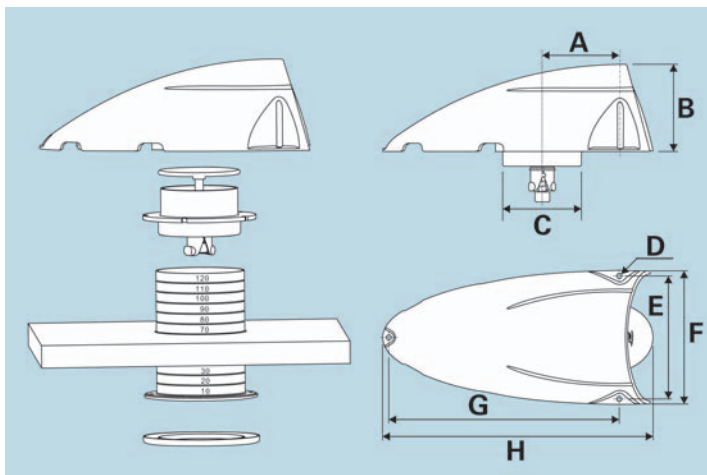

A	3.0" (75mm)
B	3.3" (85mm)
C	Ø3.5" (90mm)
D	Ø.2" (.5mm)
E	4.7" (120mm)
F	5.1" (130mm)
G	8.8" (224mm)
H	10.4" (263mm)

Accessories

- 51640 White trim ring
- 51641 Wood trim ring
- 51642 Chrome trim ring

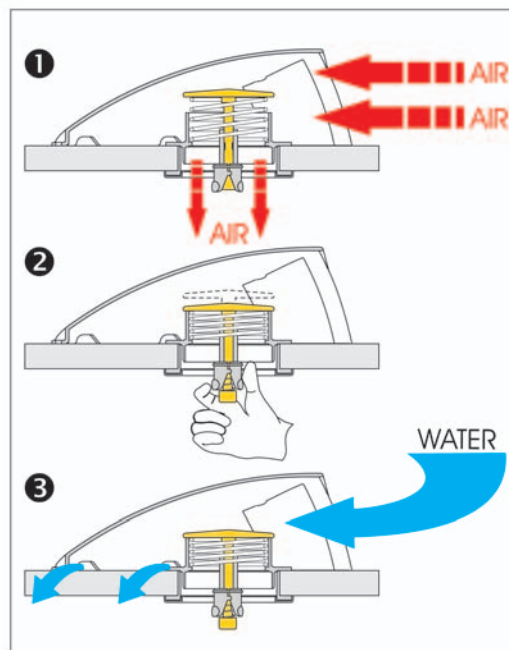

1. Dorade is open and cabin is ventilated.
2. In case of heavy rain or a strong wave the dorade can be shut off from the cabin.
3. Once the dorade is shut off water evacuates along the sides of the box.

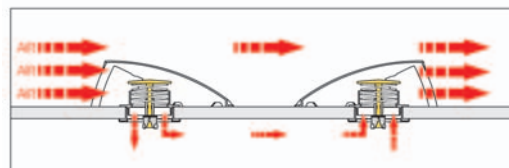

Equally suitable to allow air in and out

Omnidirectional Hatch Scoop

37996

- Keeps the air flowing no matter which way the wind is blowing
- Ultralight 100% polyester fabric
- Durable, reinforced seams
- Yellow and white



Hatch Scoop

37995

- Ultralight 100% polyester fabric
- Tensioning fiberglass batten
- Durable, reinforced seams
- Yellow and white



Cool'n Dry Dorades



- Unique weight sensitive baffle system keeps water out
- Damper can be closed manually from inside
- Adapts to existing vents

Model	Height	Blue Cowl	Red Cowl	Spare Cowls	
				Blue	Red
A	6.4"	30837	30838	17641	28865
B	11.8"	30841	30842	17639	28867
C	8.4"	30839	30840	31751	31753
D	11.8"	30843	30844	31752	31754

Model	Dorade only
31392	Fits 3" cowls
31393	Fits 4" cowls

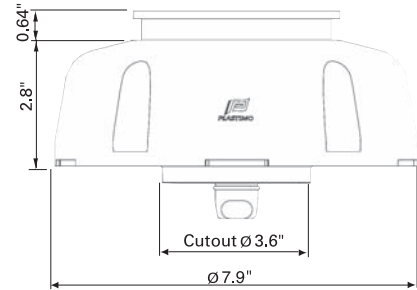

VENTILATION

Cool 'n Dry Dorades



Baffle keeps small water droplets from entering with the incoming air (1).

Heavy rain or waves activates the damper (2) that shuts down the baffle, preventing water intrusion.

As water evacuates (3), the damper lifts automatically to allow airflow again (4).

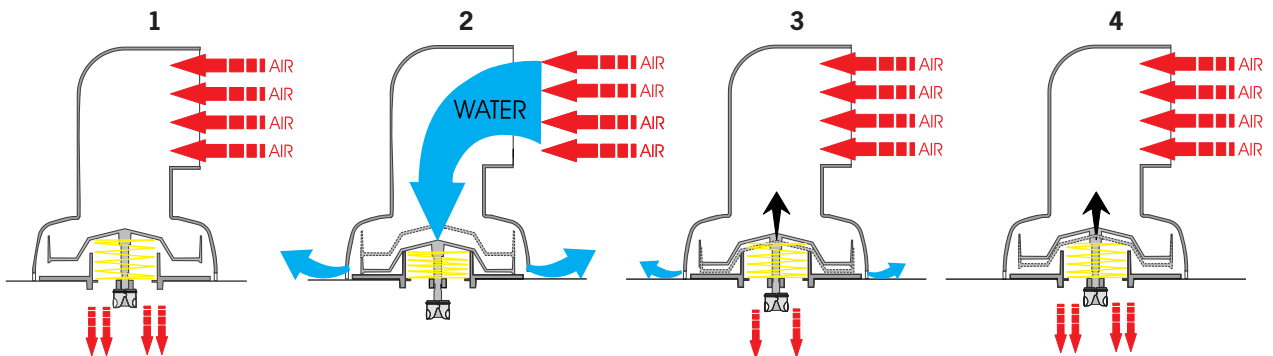

Cowl Vents & Dorades



- Cowls are soft, flexible dip-molded PVC
- UV resistant
- Turn the vent forward to let air flow in and aft to act as an exhaust vent
- Includes interior trim ring, snap-on cowl, and storm cap

Model	Blue cowl	Red cowl	Overall width	Overall height	Cutout Ø	Air flow Ø	Spare cowls	
							Blue	Red
A	16922	17626	6.8"	3.6"	3.0"	2.4"	17641	28865
B	16923	17627	7.6"	6.0"	3.6"	3.2"	17640	28866
C	16924	17624	4.8"	9.2"	3.0"	2.4"	17639	28867
D	16926	17625	5.6"	9.4"	3.6"	3.2"	17649	28868
E	17628	17629	8.0"	12.0"	4.8"	4.8"	-	28869
F	16925*	-	7.6"	11.2"	4.8"	4.8"	17648	-
G	16932	11661	10.4"	6.0"	3.0"	2.5"	17641	28865
H	16933	11662	13.4"	8.2"	3.6"	3.2"	17640	28866

*Threaded aluminum deck ring



- Use a dorade model to prevent rain or spray from entering through the cowl
- Rigid ABS plastic dorade
- Deck cutout is at opposite end of the dorade from the cowl, and is protected by the sleeve that prevents water from flowing into the cabin
- Includes dorade, cowl, storm cap, thru-deck sleeve, and interior trim ring

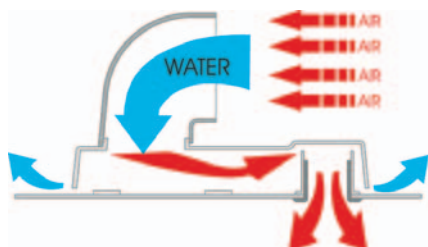

Accessories

- 16930 Deck ring and screw-on cover for model A and C
- 16929 Deck ring and screw-on cover for model B and D
- 12809 Cover for model E
- 16927 Anti-water intrusion sleeve for model B and D